

ASSEMBLY INSTRUCTION

1

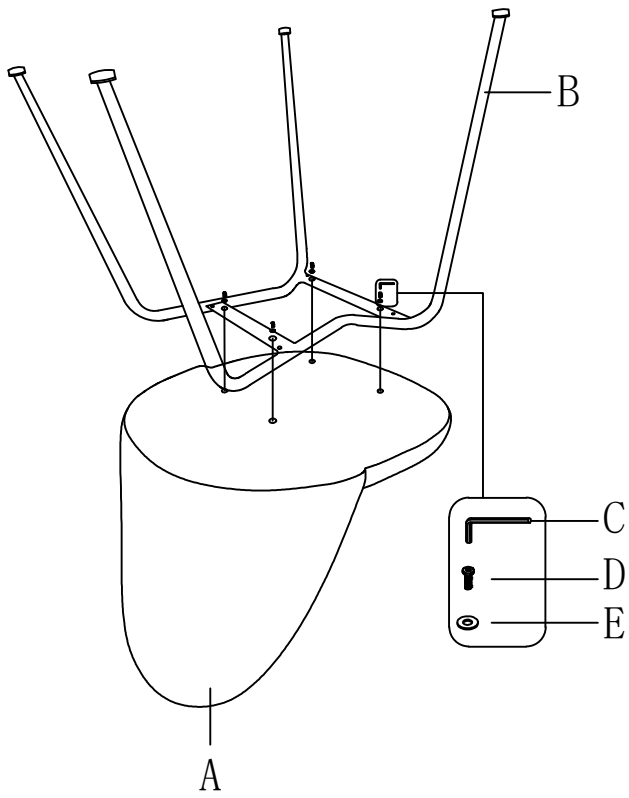

2

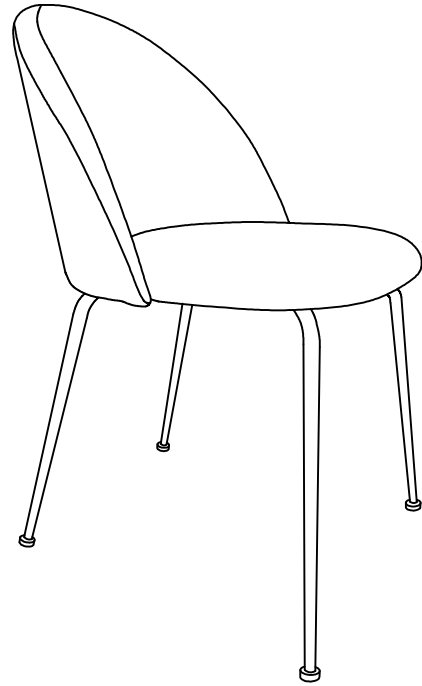

A X1	B X1
C X1	D X4
E X4	