









# Assembly Instruction

## HARDWARE LIST:

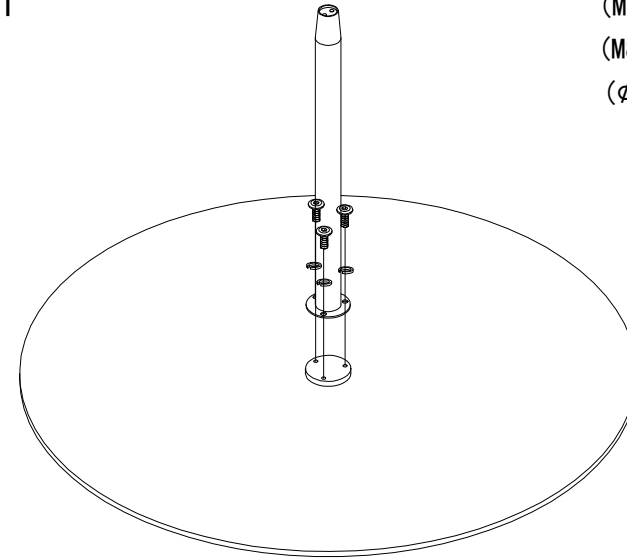



PACKAGE	DESCRIPTION	PART PHOTO	QTY	PACKAGE	DESCRIPTION	PART PHOTO	QTY
3/3	SCREW (M8*12)		3PCS				
	SCREW (M8*90)		2PCS				
	WASHER (φ18-8*1.5)		2PCS				
	SPRING SHIM (M8*2)		3PCS				
	ALLEN KEY (φ5)		1PCS				

## STEP 1







- (M8\*12  3PCS)
- (M8\*2  3PCS)
- (φ5  1PCS)

## PART LIST:

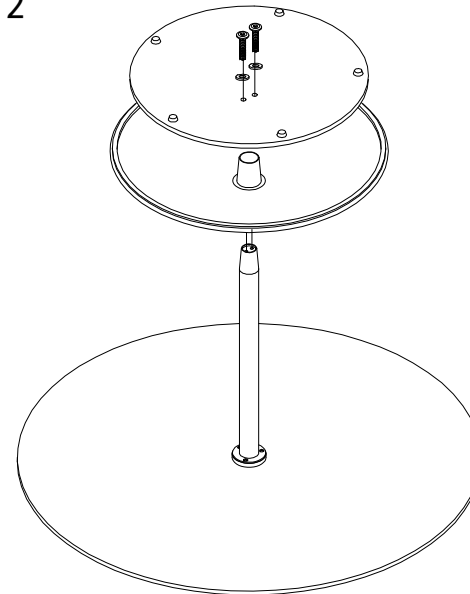
PACKAGE	DESCRIPTION	PART PHOTO	QTY	PACKAGE	DESCRIPTION	PART PHOTO	QTY
1/3	GLASS TOP		1PCS				
2/3	CROSS BAR		1PCS				
3/3	BAR TRAY		1PCS				
	CHASSIS		1PCS				
	HARDWARE		1PCS				

## STEP 2



- (M8\*90  2PCS)
- (φ18-8\*1.5  2PCS)
- (φ5  1PCS)

## FINISH

